

# Limit-value switch, input DC-voltage

- Straightforward application
- Suitable for severe operating conditions
- Compact construction
- Galvanic isolation of the input and output signal to the operating voltage
- Switching point freely adjustable by drum scale
- Anti-tamper seal for drum scale
- Meet high EMC-requirements
- **CE requirements**
- Volt-free output as make-and-break contact or make-contact
- Open-circuit or closed-circuit variants available
- Test function to simulate an increased sensor signal without critical machine loading (RG5...-S)
- Self-holding function of output relay (RG5...-S)
- Short circuit and broken-wire monitoring with live-zero signals
- Operating characteristics displayed by integrated LEDs
- Flame-inhibiting and self-extinguishing body

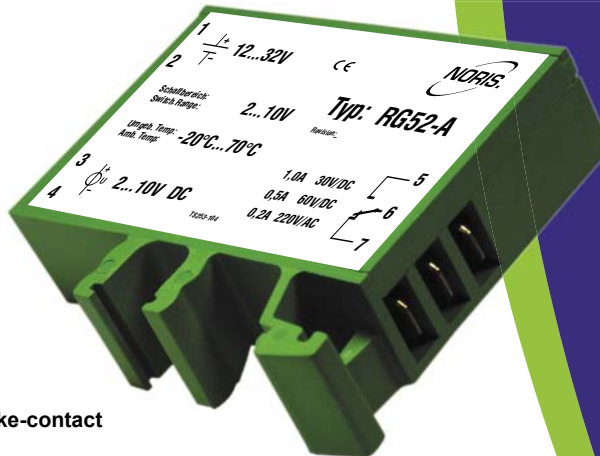

Image  
RG52-A



## Limit-value switches of series 5

Limit value switches of the series 5 are designed to monitor and process electric measured variables.

Working principle: When the actual value of the measuring signal supplied reaches the setpoint, the built-in relay will operate. The switching status of the relay contact may, for instance, be monitored or individually processed by a machine controller.

## General notes on Type RG5..

### Description RG5..

- Designed to monitor a direct current
- Devices from 0 ... 10 V/DC without live-zero-monitoring
- Devices from 2 ... 10 V/DC with live-zero-monitoring
- Switching point settings possible over complete input range by means of drum scale

### Integrity and short-circuit monitoring of input signal

The integrated signal monitoring of the live-zero device provides monitoring of the sensor signal for broken wire and short circuit. If the measured signal falls below the limit at approx. 1 V, the relay will operate. The red LED will light up and the green LED will be flashing. Limit-value switches with 0 ... 10 V/DC input are not available with broken-wire and short-circuit alarm of the sensor circuit.

### Volt-free relay contact, closed-circuit or open-circuit version

A volt-free relay contact is provided as a make-and-break contact for outputting and further processing. In addition, there is a choice between closed-circuit and open-circuit devices.

In the case of closed-circuit devices, the output relay is pulled up in the normal state of operation with the operating voltage applied. It drops off upon the limit-value being exceeded or if the operating voltage fails.

In the open-circuit variant, the output relay pulls up when the limit-value is exceeded with the operating voltage applied. Failure of the voltage will not result in any switching function below the switching point.

### Testing and self-holding function of RG51-S

The Typ RG51-S have the integrated special functions testing and self-holding.

The testing function offers while the contacts 2 and 5 are connected, the limit-value signal selected on the drum scale is lowered by about 15%. In a speed monitoring application, this means that an overspeed condition can be simulated within the normal range without it being necessary to run the machine in the critical range.

The self-holding function of the RW5...-S devices hold the output relay to be kept latched after the switching operation until the relay is unlatched. The unlatching function is activated when the operating voltage as been interrupted for at least 500 ms. After activation of the unlatching function, the limit-value switch will return to its normal operating condition and will be fully operational after approximately 3 seconds

## Technical Data

Series RG5..., RG5...-S	
Operating voltage	$U_o = 12 \dots 32 \text{ V/DC}$ , $U_R = 24 \text{ V/DC}$
Ripple	$< 20\% U_o$
Reverse voltage protection	Integrated
Overvoltage	2.5 times $U_R$ up to 2 ms
Voltage drops	100% up to 10 ms
Galvanic isolation	Between input signal and operating voltage
Power consumption	Approx. 50 mA (24 V/DC)
Input signal	DC-voltage RG51.. 0 ... 10 V/DC, RG52.. 2 ... 10 V/DC
Input resistance	Approx. 10 k $\Omega$
Output contact	Volt-free make-and-break contact, closed circuit or open circuit (RG5..) Volt-free NOC, closed circuit or open circuit (RG5...-S)
Maximal switching capacity	30 W (1 A at 30 V/DC; 0.5 A at 60 V/DC) 40 W (0.2 A at 220 V/AC)
Switching point	Adjustable on tamper-proof drum scale between 0 ... 10 V/DC for RG51..., 2 ... 10 V/DC for RG52..
Reproducibility	$< \pm 0.2\%$
Linearity of scale	$< \pm 1.5\%$
Hysteresis	Approx. 1.5%
Test function	Connect 2/5 to lower switching point approx. 15% (only RG5...-S)
Self-holding function	Relais is held till operating voltage is interrupted min. 500 ms (RG5...-S)
Sensor monitoring	Broken-wire and short circuit below 1 V/DC (only 2 ... 10 V devices)
Error class	IEC51-1 1.5%
Temperature sensitivity	$< \pm 0.1\% \text{ je } 10^\circ \text{K}$
Voltage sensitivity	$< \pm 0.1\%$ for 10% change in operating voltage
Measuring suppression	Approx. 2 s after turning on the operating voltage
Vibration resistance	IEC60068-T2-6 15g increased strain, characteristic 2 (10 ... 100 Hz)
Shock resistance (impact)	DIN IEC60068-T2-27 300 m/s <sup>2</sup> with 18 ms dwell time
Climatic test	IEC60068-T2-30
Operating temperature	-20 °C ... +70 °C
Shelf temperature	-45 °C ... +85 °C
Humidity	RH 96% maximum
ESD	IEC61000-4-2 $\pm 8 \text{ kV}$
Electromagnetic field	IEC61000-4-3 10 V/m $f=10 \text{ kHz} \dots 2000 \text{ MHz}$ , 80% AM @ 1 kHz 10 V/m $f=900 \text{ MHz} \dots 5 \text{ MHz}$ , 50% AM @ 200 Hz 10 V/m $f=1800 \text{ MHz} \dots 5 \text{ MHz}$ , 50% AM @ 200 Hz
Burst	IEC61000-4-4 $\pm 2 \text{ kV}$ supply $\pm 1 \text{ kV}$ sensor
Surge	IEC61000-4-5 sym. $\pm 1 \text{ kV}$ ( $R=2 \Omega$ ) asym. $\pm 2 \text{ kV}$ ( $R=2 \Omega$ )
HF-susceptibility	IEC61000-4-6 3 V <sub>pp</sub> 80% AM @ 1 kHz $f=0.01 \dots 100 \text{ MHz}$
LF-susceptibility	IEC60553 3 V <sub>pp</sub> 0.05 ... 10 kHz
Interference field intensity	Basis CISPR 16-1, 16-2 reduced characteristic
Connection	DIN46244 flat connector, gold-plated A6.3 x 0.8
Protection class	DIN EN60529 Body IP20, terminals IP00
Mounting	Snap-fit on top-hat channel or G-channel
Installed position	Any
Body material	Thermoplastic polyester, green, fire protection class V0
Weight	55 g
Standard supply	CE requirements complied with, DIN EN 61000-6-2, DIN EN 61000-6-4, DIN EN 50155, approved by GL, LR, ABS, DNV, BV

## Type key / variants

Input range:	0 ... 10 V/DC	2 ... 10 V/DC
Make-and-break in closed circuit	RG51	RG52
Make-and-break in open circuit	RG51-A	RG52-A
NOC in open circuit with test function and self-holding function	RG51-S	

### Device codes

R	Limit-value switch
G	Input signal
G	DC-voltage
5	Type series
5	Type 5
1	Input range
1	0 ... 10 V/DC
2	2 ... 10 V/DC
	Variante
	Output contact as make-and-break contact in closed circuit
- A	Output contact as make-and-break contact in open circuit
- S	Output contact as NOC in open circuit with test function and self-holding function

R G 5 1 -A (RG51-A)

## Other Data

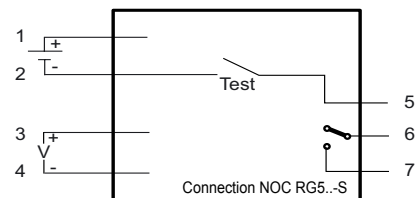
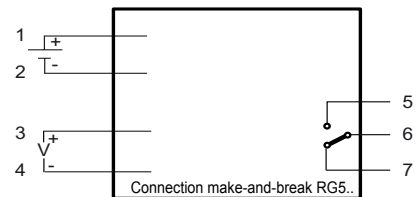
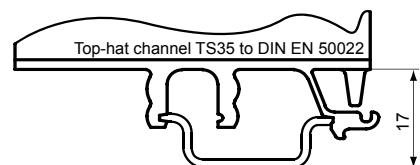
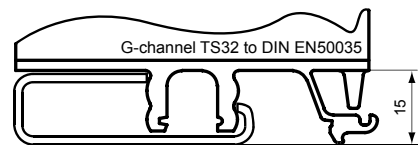
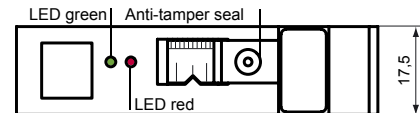
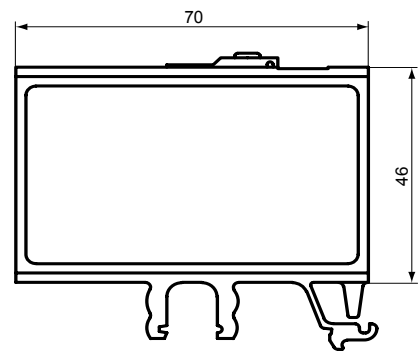

### Relais position and LED code

RG5..	6/7 RG5..-A	5/6 RG5..-A	6/7 RG5..	5/6 RG5..	LED grün	LED rot
U < switch point	x	-	-	x	x	-
U > switch point	-	x	x	-	x	x
Broken-wire in sensor circuit (Live-Zero)	-	x	x	-	o	x
Short circuit in sensor circuit (Live-Zero)	-	x	x	-	o	x

RG5...-S	6/7 RW5...-S	LED grün	LED rot
U < switch point	-	x	-
U > switch point	x	x	x

x = contact closed / LED lighting  
- = contact open / LED out  
o = LED flashing



NORIS Automation GmbH  
Muggenhofer Strasse 95

D - 90429 Nürnberg  
Germany  
Tel.: +49 (0)9 11/32 01-0  
Fax: +49 (0)9 11/32 01-150  
info@noris-automation.com  
www.noris-automation.com